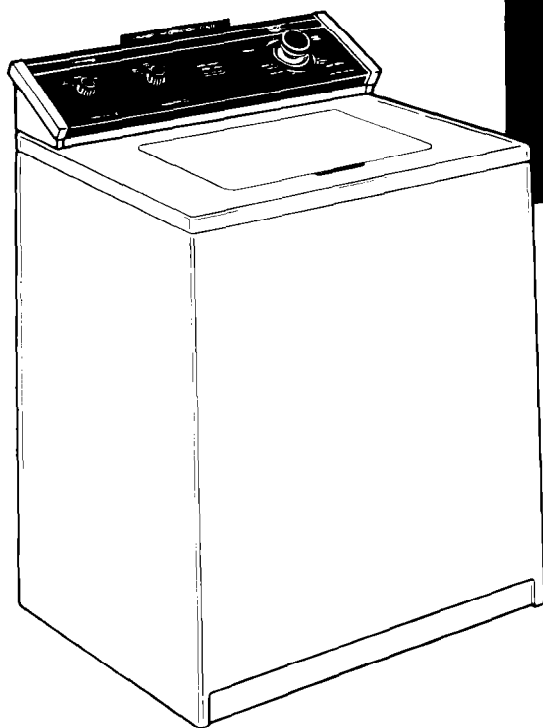

use & care guide

The Whirlpool logo, consisting of the word "Whirlpool" in a stylized, serif font, with a graphic of three concentric circles above the letter 'i' and a large, sweeping oval shape that encircles the text.

AUTOMATIC WASHER

**Super Capacity
Model
LA5578XS**

Microwave Ovens, Trash Compactors, Room Air Conditioners, Dehumidifiers, Automatic Washers, Clothes Dryers, Freezers, Refrigerator



Contents

	Page		Page
PARTS AND FEATURES	2	For a Drain and Spin	10
IMPORTANT SAFETY		Liquid Bleach Dispenser	11
INSTRUCTIONS	3	MAGIC CLEAN® Lint Filter	11
OPERATING INSTRUCTIONS	4	CARING FOR YOUR WASHER ..	12
Starting Your Washer	4	Winterizing	13
What Happens in Each Cycle	6	IF YOU NEED SERVICE OR	
OTHER OPERATING		ASSISTANCE	14
INSTRUCTIONS	10	WASHER WARRANTY	16
For a Rinse and Spin	10		

©1987 Whirlpool Corporation

Parts and features

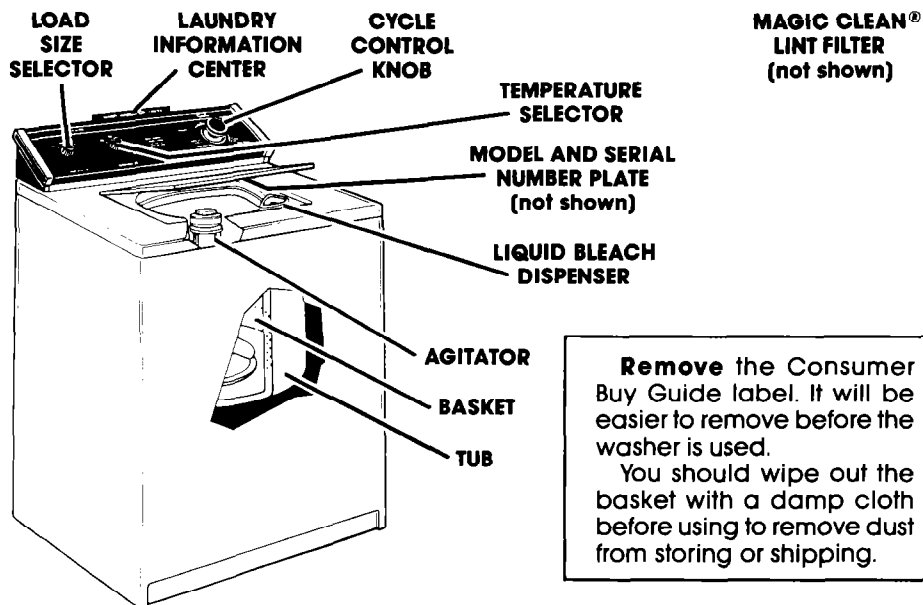

Copy your Model and Serial Numbers here

When you need service or call with a question, have this information ready:

1. Complete Model and Serial Numbers (from plate under the lid near the hinge).

2. Purchase date from sales slip.

Copy this information in these spaces. Keep this book, your "Laundry Guide" and sales slip in the Laundry Information Center.

Please complete and mail the Owner Registration Card furnished with this product.

Model Number

Serial Number

Purchase Date

Service Company
Phone Number

Important safety instructions



WARNING – To reduce the risk of fire, electric shock, or injury to persons when using your washer, follow basic precautions, including the following:

Read these Laundry Instructions for important use and safety information before using your washer.

NEVER wash items cleaned, washed, soaked in or spotted with wax, paint, gasoline, or flammable fluids in the washer. The fumes can create a **FIRE HAZARD** or **EXPLOSION**. **ALWAYS** hand launder and air dry fabrics containing these materials.

NEVER allow children to operate, play with, or crawl inside the washer. Close supervision of children is necessary when the washer is used near children. When discarding an old washer, **ALWAYS** remove the lid to prevent accidental entrapment.

NEVER put your hands into the washer until all motion stops. If the lid is opened while the basket is spinning, the basket will automatically stop in a few seconds.

DO NOT tamper with controls.

NEVER use or store flammable fluids (dry-cleaning solvents, gasoline, kerosene) in or near your washer. Do not add flammable fluids to the wash water. These substances give off vapors that can create a **FIRE HAZARD** or **EXPLOSION**.

WARNING: If hot water has not been used recently (usually two weeks or longer), hydrogen gases may build up in the water heater and the hot water pipes. **HYDROGEN GAS IS EXPLOSIVE**. To prevent injury or damage, before using your washer, turn on all hot water faucets and allow water to run for several minutes. This will allow gases to escape. Do not smoke or use any open flame near the faucet while it is open.

You are personally responsible for making sure that your washer:

- is installed, repaired, and parts replaced by a qualified person.
- is properly installed and leveled on a floor that can support the weight.*
- is connected to the right kind of outlet, electric supply, water supply and drain.*
- is properly grounded.*
- is properly maintained.
- is protected from the weather and kept where the temperature will not fall below freezing.

*See the "Installation Instructions."

– SAVE THESE INSTRUCTIONS –

Additional Safety Instructions and Your Responsibilities

ALWAYS store detergent, laundry aids and other materials in a cool, dry place where children can't reach them – in a locked cabinet if possible.

ALWAYS read and follow instructions on packages of detergent and laundry aids – especially warnings and precautions.

HAZARDOUS FUMES can be formed if chlorine bleach is used in the same wash as ammonia or acids such as vinegar or rust remover.

ALWAYS unplug the power supply cord before attempting to service the washer.

DO NOT machine wash glass fiber materials. Small particles can stick to fabrics washed in following loads and cause skin irritation.

You are personally responsible for making sure that your washer:

- is used only for jobs normally expected of home automatic washers.
- is not run by children or anyone unable to operate it properly.

Operating instructions

Starting Your Washer



Be sure to measure and add detergent, then place a sorted load in the washer before starting it.

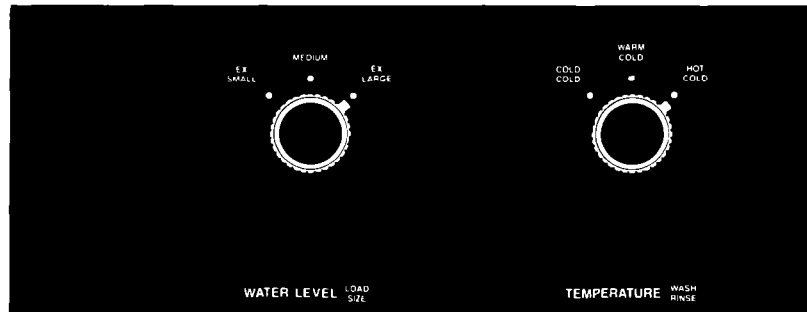

1. Select a LOAD SIZE

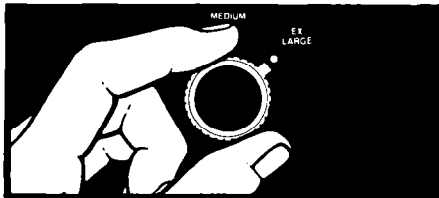

- Turn the knob to point at a setting that describes the size of load you want to wash.
- Set the knob anywhere on or between EX SMALL (a few small items) and EX LARGE (a full load).

NOTE: Use the EX LARGE water level for best permanent press results.

2. Select WATER TEMPERATURES

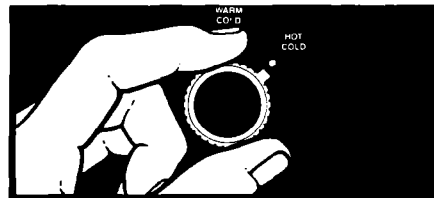

- Match the wash and rinse water temperature to the type of fabrics and soils being washed.
- All rinses are cold. Cold rinses save energy and help prevent wrinkles from setting into fabrics.

Recommended wash temperatures can be found in your "Laundry Guide."

IMPORTANT: Use warm water with the PERM'T PRESS or KNITS/GENTLE cycles. For heavily soiled permanent press or knit clothes, pre-wash or pre-soak before washing in warm water.

LOAD SIZES AND WATER LEVELS

For best cleaning results, the load must be able to move freely in the water. Too big a load or too little water can cause wear or tearing of load items.

*Approximate fill with load.

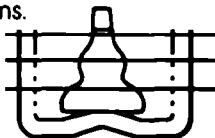

CAUTION:
DO NOT
OVERLOAD WASHER.

EX LARGE (21.7 gal./82.1 L)*
MEDIUM (16.8 gal./63.6 L)*
EX SMALL (11.9 gal./45.0 L)*

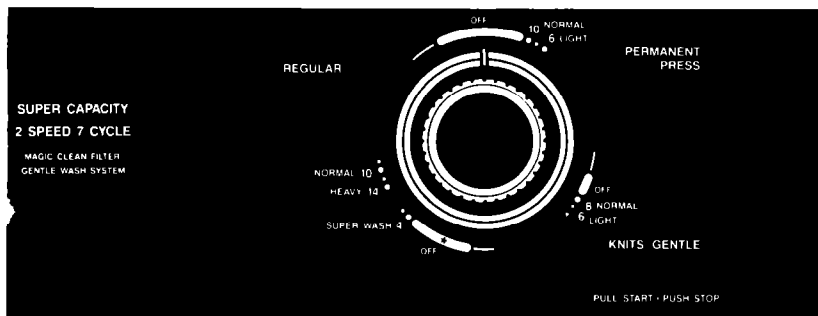

3. Select CYCLE and WASH TIME; Start the washer

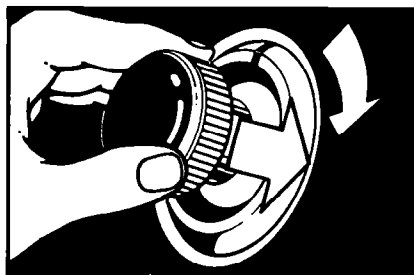

A. Push in the Control Knob and turn it to the right. It must be pushed in and turned only clockwise.

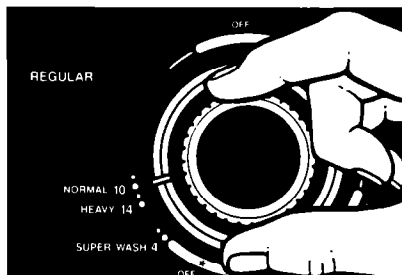

B. Stop on a number in the cycle you want. The numbers are minutes of wash time. The drawing shows 10 minutes of agitation in the REGULAR NORMAL Cycle.

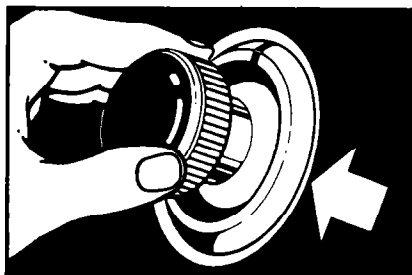

C. Start the washer by pulling out the Control Knob. The washer will fill to the level you set with wash water of the selected temperature. After filling, the washer will agitate for the selected number of minutes.

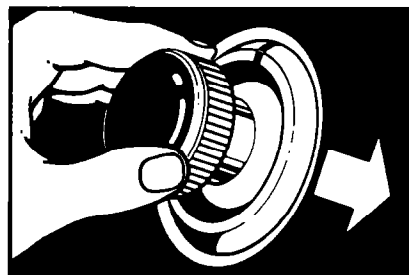

D. To stop the washer at any time, push in the Control Knob. To restart the washer, pull out the Control Knob.

NOTE: You may hear the sound of water spraying during the spin parts of some cycles. In some cycles, cold water is sprayed on the spinning load to help with the rinsing.

Gentle Wash System

For better fabric care in the REGULAR and PERMANENT PRESS cycles, the agitation speed is reduced during the last few minutes of wash time.

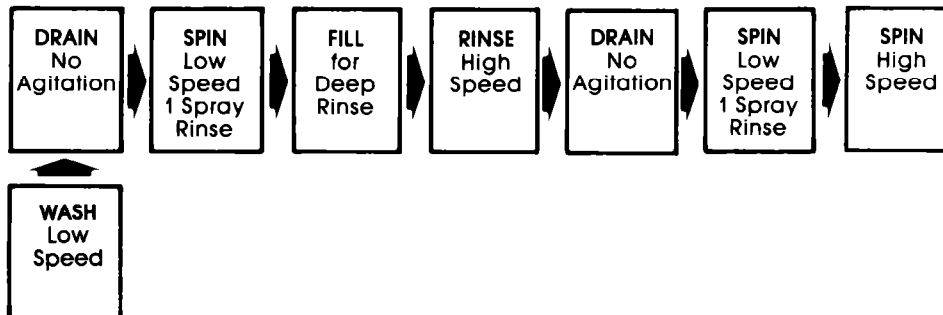
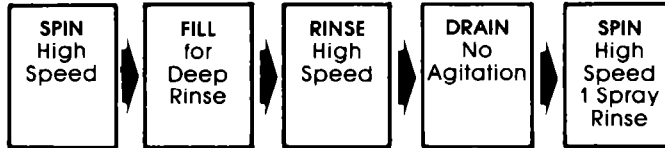

*** IMPORTANT: THE WASHER WILL PAUSE BRIEFLY THROUGHOUT EACH CYCLE.** These pauses are normal. They allow for the reversing of the motor, normal washer operation, and the cool down portion of the PERMANENT PRESS Cycle.

PERMANENT PRESS LIGHT Cycle

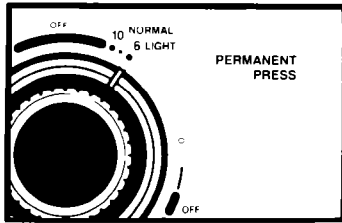

A cycle designed for lightly soiled permanent press and some synthetic fabrics. The **cool-down** rinse helps keep wrinkles from setting into these items.

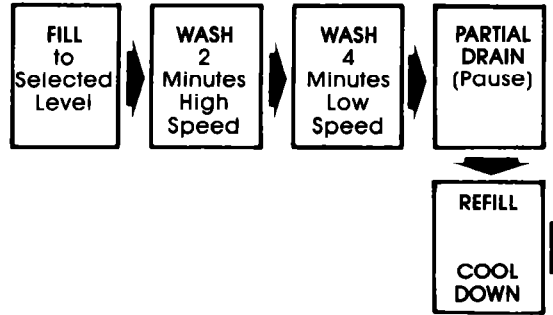

KNITS/GENTLE NORMAL Cycle

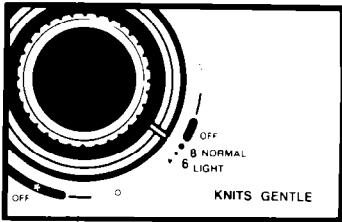

A cycle that gently washes and spins moderately soiled delicate items and washable knits.

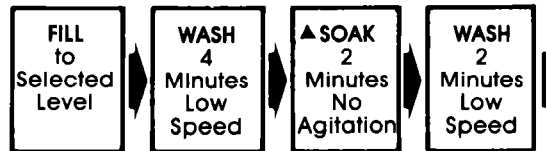

▲ Indicates the machine is pausing for a brief soak period.

KNITS/GENTLE LIGHT Cycle

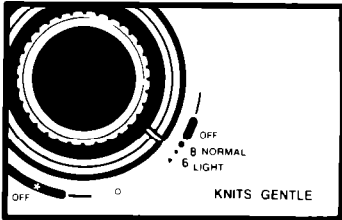

A cycle that gently washes and spins lightly soiled delicate items and washable knits.

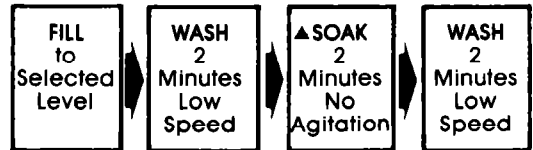

▲ Indicates the machine is pausing for a brief soak period.

SUPER WASH Cycle

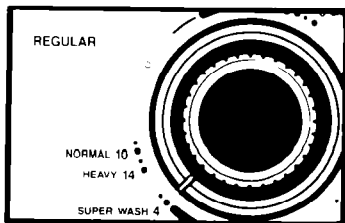

Use for washing heavily soiled loads that require maximum soil removal. **Double the amount of detergent recommended when using the SUPER WASH Cycle.**

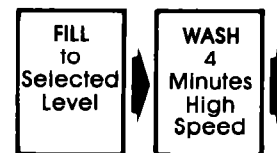

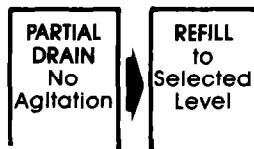
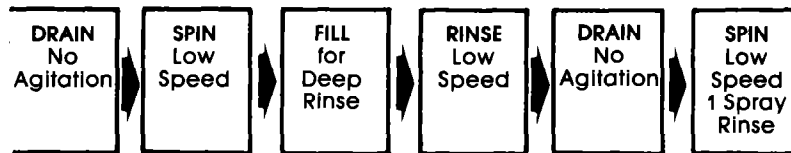
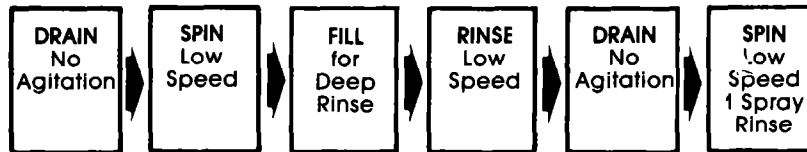
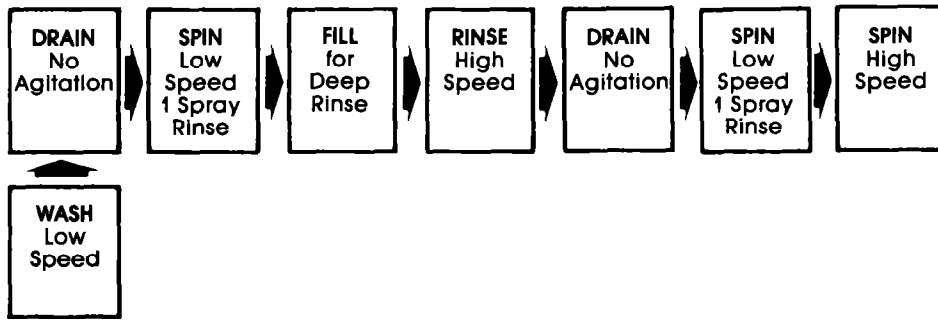

The washer will proceed to the REGULAR/HEAVY Cycle. If you want a different cycle to follow SUPER WASH, push in the cycle control knob, turn to the cycle and time you want, pull knob out to start.

Other operating instructions

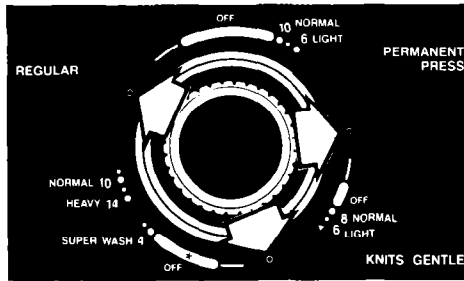

For a rinse and spin

You may need an extra rinse and spin for heavily soiled loads which need more detergent. (Extra detergent can require an extra rinse.)

1. Push Control Knob in.
2. Turn clockwise to any  on the dial.
See above drawing.
3. Pull Control Knob out. The washer will fill to selected level; agitate 2 minutes; drain and spin.

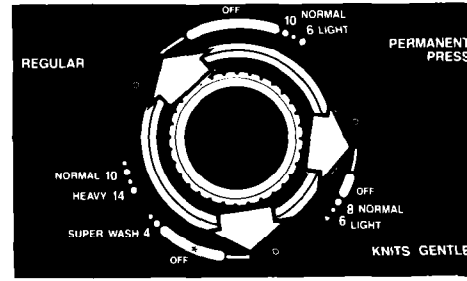

For a drain and spin

Your washer can be set to drain and spin out water.

1. Push Control Knob in.
2. Turn clockwise to the bar just before the OFF area in any cycle. **See above drawing.**
3. Pull Control Knob out. The washer will drain and spin.

For agitation and spin speeds in each cycle, see pages 6-9.

Liquid bleach dispenser

Always measure bleach. Do not guess. Never use more than 1 cup (250 mL) for a full load. Use less with lower water level settings. Follow directions on bottle for safe use. Use a cup with a pouring spout to avoid spilling.

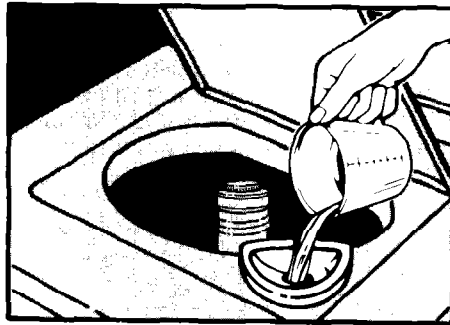
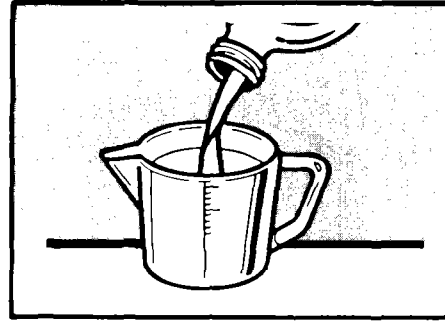

1. Load the washer first.
2. Pour **measured** bleach carefully into dispenser. **DO NOT** let bleach splash, drip or run down into the washer basket. **Undiluted bleach will damage any fabric it touches.**
3. Start the washer. Bleach will be diluted automatically during the wash part of the cycle.

For more information on bleaching, see your "Laundry Guide."

MAGIC CLEAN® lint filter

The lint filter in your washer cleans itself. Collected lint is drained away with the wash and rinse water.

If your washer drains into a tub, remove any lint collected in the drain or strainer.

Caring for your washer

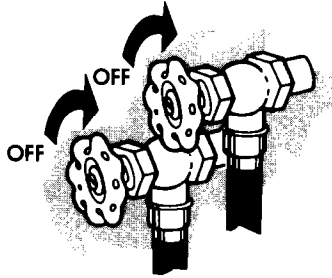

WHEN NOT WASHING, keep both water faucets turned off, this takes the pressure off the water inlet valve and hoses.

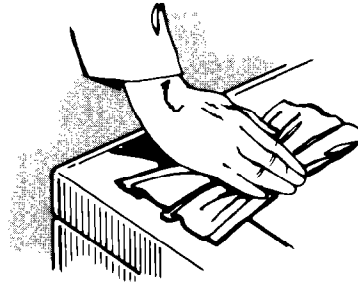

AFTER WASHING, use a soft dry cloth to wipe the outside and inside dry. Leave the lid up until the basket is dry. **Wipe up spills right away.** Spills can dull or damage the finish.

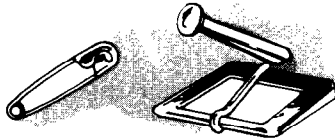

REMOVE SHARP OBJECTS such as pins, buckles, etc., from clothes before washing. Close metal zippers.

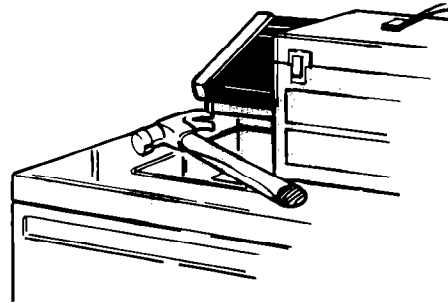

SHARP OR HEAVY OBJECTS should never be put on or in the washer. Check pocket for bolts, nuts, tools, etc.

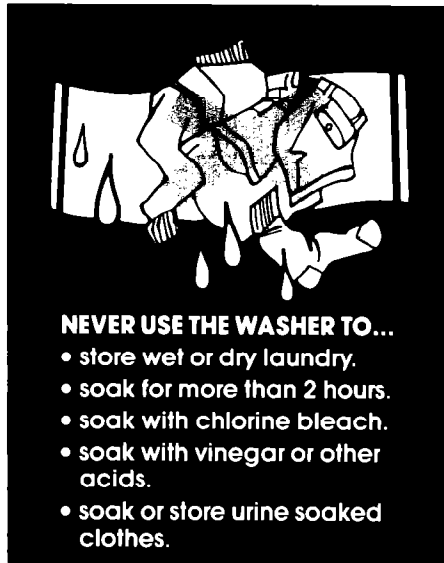

NEVER USE THE WASHER TO...

- store wet or dry laundry.
- soak for more than 2 hours.
- soak with chlorine bleach.
- soak with vinegar or other acids.
- soak or store urine soaked clothes.

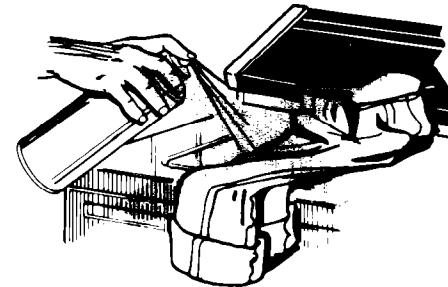

SOME PRETREATMENT PRODUCTS can damage washer and dryer dials, consoles and finishes. Do not use these products on or near your washer or dryer.

Service or performance problems caused by the use of any product not manufactured by Whirlpool Corporation are the responsibility of the manufacturer of that product.

Winterizing

Because some water stays in the washer, freezing can cause a lot of damage. If your washer is **stored or moved** during the cold weather...

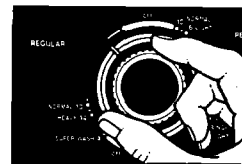
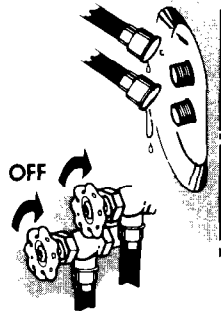
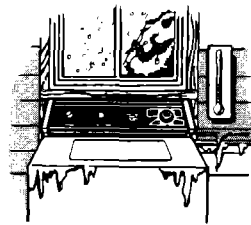

1. Shut off both water faucets. Disconnect and drain water inlet hoses.
2. Put a quart of R.V. or automobile type antifreeze in the basket.
3. Set the washer for a DRAIN and SPIN (see page 10). Let it run for about 30 seconds to mix the antifreeze and water.

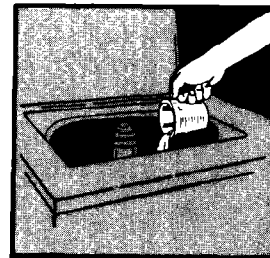
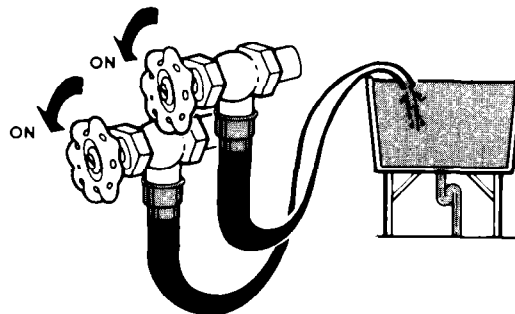

To use the washer again...

1. Flush water pipes and hoses.
 2. Connect hoses to the washer
 3. Turn on the water faucets.
4. Run the washer through a complete cycle with one cup of detergent to clean out the antifreeze.

If you need service or assistance, we suggest you follow these five steps:



1. Before calling for assistance...

Performance problems often result from little things you can find and fix yourself without tools of any kind.

If your washer does not fill:

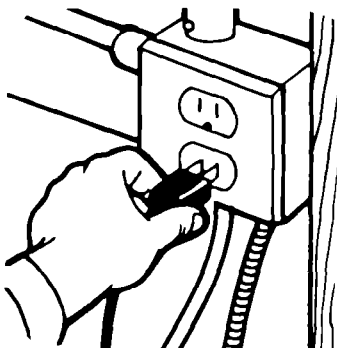

- Is the power supply cord plugged into a live circuit with the proper voltage?

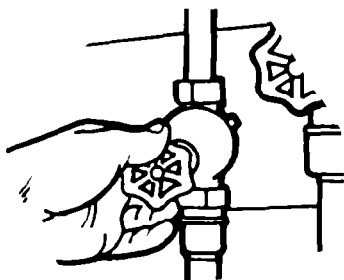

- Are both water faucets open?

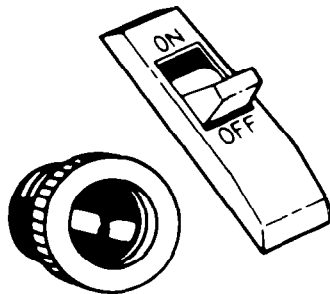

- Have you checked your home's main fuses or circuit breaker box?
- Are the water supply hoses kinked?
- Is the Cycle Control Knob set and pulled out?

If your washer does not spin:

- Is the lid closed?
- Is the power supply cord plugged into a live circuit with the proper voltage?
- Have you checked you home's main fuses or circuit breaker box?

If your washer stops during a cycle:

- Remember, the washer pauses briefly at different times in each cycle. These pauses are normal.

If your washer fills and drains without running:

- Make sure that the Cycle Control Knob is pointing to a number in the cycle.

Make sure the drain hose is higher than the water level in the washer. If it isn't:

- The washer may seem to be draining during wash and rinse cycles.
- Water can siphon out. (See "Installation Instructions.")

2. If you need assistance*...

Call Whirlpool COOL-LINE® service assistance telephone number. Dial free from anywhere in the U.S.:
1-800-253-1301

and talk with one of our trained Consultants. The Consultant can instruct you in how to obtain satisfactory operation from your appliance or, if service is necessary, recommend a qualified service company in your area.

3. If you need service*...



Whirlpool has a nationwide network of franchised TECH-CARE® Service Companies. TECH-CARE service technicians

are trained to fulfill the product warranty and provide after-warranty service, anywhere in the United States. To locate TECH-CARE service in your area, call our COOL-LINE service assistance telephone number (see Step 2) or look in your telephone directory Yellow Pages under:

APPLIANCES - HOUSEHOLD -
 MAJOR - SERVICE & REPAIR

ELECTRICAL APPLIANCES -
 MAJOR - REPAIRING & PARTS

OR

WHIRLPOOL APPLIANCES
 FRANCHISED TECH-CARE SERVICE

WHIRLPOOL APPLIANCES
 FRANCHISED TECH-CARE SERVICE

SERVICE COMPANIES

SERVICE COMPANIES

XYZ SERVICE CO
 123 MAPLE

999-9999

XYZ SERVICE CO
 123 MAPLE

999-9999

OR

WASHING MACHINES, DRYERS
 & IRONERS - SERVICING

WHIRLPOOL APPLIANCES
 FRANCHISED TECH-CARE SERVICE

SERVICE COMPANIES

XYZ SERVICE CO
 123 MAPLE

999-9999

4. If you have a problem*...

Call our COOL-LINE service assistance telephone number (see Step 2) and talk with one of our Consultants, or if you prefer, write to:

Mr. Robert Stanley
 Division Vice President
 Whirlpool Corporation
 2000 M-63
 Benton Harbor, MI 49022

5. If you need FSP® replacement parts*...

FSP is a registered trademark of Whirlpool Corporation for quality parts. Look for this symbol of quality whenever you need a replacement part for your Whirlpool appliance. FSP replacement parts will fit right and work right, because they are made to the same exacting specifications used to build every new Whirlpool appliance.

*If you must call or write, please provide: model number, serial number, date of purchase, and a complete description of the problem. This information is needed in order to better respond to your request for assistance.

WHIRLPOOL® AUTOMATIC WASHER WARRANTY

LENGTH OF WARRANTY	WHIRLPOOL WILL PAY FOR
FULL ONE-YEAR WARRANTY From Date of Purchase	FSP® replacement parts and repair labor to correct defects in materials or workmanship. Service must be provided by a franchised TECH-CARE® service company.
LIMITED FIVE-YEAR WARRANTY From Date of Purchase	FSP replacement parts for any part of gearcase assembly if defective in materials or workmanship. The gearcase assembly is shown below.
LIMITED TEN-YEAR WARRANTY From Date of Purchase	FSP replacement of outer tub should it crack, or fail to contain water, due to defective materials or workmanship.
WHIRLPOOL WILL NOT PAY FOR	
<p>A. Service calls to:</p> <ol style="list-style-type: none"> 1. Correct the installation of the washer. 2. Instruct you how to use the washer. 3. Replace house fuses or correct house wiring or plumbing. <p>B. Repairs when washer is used in other than normal, single-family household use.</p> <p>C. Pick up and delivery. This product is designed to be repaired in the home.</p> <p>D. Damage to washer caused by accident, misuse, fire, flood, acts of God or use of products not approved by Whirlpool.</p> <p>E. Any labor costs during the limited warranties.</p>	

WHIRLPOOL CORPORATION SHALL NOT BE LIABLE FOR INCIDENTAL OR CONSEQUENTIAL DAMAGES. Some states do not allow the exclusion or limitation of incidental or consequential damages so this limitation or exclusion may not apply to you. This warranty gives you specific legal rights, and you may also have other rights which vary from state to state.

Outside the United States, a different warranty may apply. For details, please contact your franchised Whirlpool distributor or military exchange.

**GEARCASE ASSEMBLY
COVERED BY YOUR
WARRANTY**

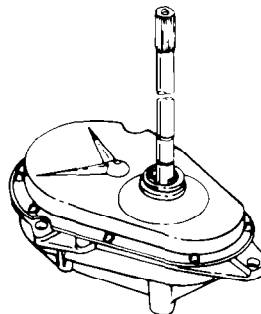

Whirlpool